

# User Manual

PAP System(iBreeze CPAP System)



***resvent***

## **Contents**

1 Welcome.....	1
2 Intended Use.....	1
3 Contraindications.....	1
4 Safety Information.....	2
5 Symbol.....	6
6 System Contents.....	7
7 System Overview.....	8
8 Navigating the Device Screens.....	12
9 Operation.....	12
10 Device Alert.....	21
11 Troubleshooting.....	24
12 Cleaning and Maintaining.....	26
13 Maintenance.....	27
14 Storage and Disposal.....	28
14.1 Storage.....	28
15 Specification.....	29
16 EMC Declaration.....	32

---

## 1 Welcome

The iBreeze CPAP Systems contains CPAP and APAP Modes. They are both continuous positive airway pressure devices.

The iBreeze CPAP Systems include the following models:

iBreeze 20C, iBreeze 20C Pro, iBreeze 20A and iBreeze 20A Pro.

### Responsibility on the Manufacturer Party

Resvent is responsible for the effects on safety, reliability and performance of this product, only if:

- All installation operations, expansions, changes, modifications and repairs of this product are conducted by Resvent authorized personnel.
- All spare parts for repair, accessories, consumable are conducted by Resvent or the authorized personnel.
- The electrical installation of the relevant room complies with the applicable national standard and the manual requirements.
- The product is used in accordance with the instruction for use.

### IMPORTANT

Read this entire guide before using the device.

## 2 Intended Use

The iBreeze™ CPAP systems delivery positive airway pressure therapy for the treatment of Obstructive Sleep Apnea (OSA) in spontaneously breathing patients weighting over 30kg (66lbs), it is for use in the home, hospital, or institutional environment.

## 3 Contraindications

When assessing the relative risks and benefits of using this equipment, the clinician should understand that this device can deliver pressures up to 20 cmH<sub>2</sub>O. In the event of certain fault conditions, maximum pressure 40 cmH<sub>2</sub>O is possible. Studies have shown that the following pre-existing conditions may contraindicate the use of CPAP therapy for some patients:

- Severe coronary artery disease
- Bullous Lung Disease
- Pathologically Low Blood Pressure
- Bypassed Upper Airway
- Pneumothorax

Caution should be used when prescribing CPAP therapy for susceptible patients such as those with: cerebral spinal fluid (CSF) leaks, abnormalities of the cribriform plate, prior history of head trauma, and/or Pneumothorax.

The use of positive airway pressure therapy may be temporarily contraindicated if you exhibit signs of a sinus or middle ear.

**Note:** In either case above, it can only be determined by a competent physician whether to use CPAP device.

## User qualifications

The person operating the device by the instruction in the user's manual is referred as the "user". In contrast, a "patient" is the person receiving the therapy. Always perform all the operating steps in accordance with the user's manual.

Some lay person can receive specified professional training about how to use the device including all related to accessories from your dealer or the manufacturer.

## 4 Safety Information



**WARNING:** Indicate the possibility of injury to the user or operator.

**CAUTION:** Indicate the possibility of damage to the device.

### WARNING:

- This manual serves as a reference. The instructions in this manual are not intended to supersede the health care professional's instructions regarding the use of the device.
- This device is not intended for life-supporting device.
- A mask should not be used unless the device is turned on, otherwise, there is danger of suffocation.
- The device must be used only with the masks and accessories recommended by Resvent. The masks and accessories are validated for use with Resvent devices.
- The exhalation port(s) associated with the mask should never be blocked. The device is intended to be used with special masks or connectors that have exhalation ports to allow continuous flow of air out of the mask. When the device is turned on and functioned properly, new air from the device flushes the exhaled air out through the mask exhalation port. However, when the device is not operating, enough fresh air will not be provided through the mask.
- If you are using a full-face mask (a mask covering both your mouth and your nose), the mask must be equipped with a safety (entrainment) valve.
- When using oxygen with this system, always make sure that the device is turned on and airflow generated before the oxygen supply is turned on. Always turn the oxygen supply off before the device is turned off, so that unused oxygen does not accumulate within the device enclosure and create a risk of fire.
- Sources of oxygen must be located more than 1 m from the equipment to avoid the risk of fire and burns.
- Do not connect the device to an unregulated or high-pressure oxygen source.
- Oxygen must not be used while smoking or in the presence of an open flame.
- Do not use the device in the presence of a flammable anaesthetic mixture in combination with oxygen or air, or in the presence of nitrous oxide.
- Do not use the device near a source of toxic or harmful vapors.
- Do not use this device if the room temperature exceeds 35°C (95°F). If the device is used at room temperatures warmer, than 35°C (95°F), the temperature of the airflow may exceed 43°C (109°F). This could cause irritation or injury to your airway.
- The time required for the CPAP System to warm from the minimum storage temperature between uses until the CPAP System is ready for its intended use when the ambient temperature is 20°C is at least 1h, and
- The time required for the CPAP System to cool from the maximum storage temperature between uses until the CPAP System is ready for its intended use when the ambient temperature is 20°C is at least 1h.
- The device is not used exceed the specified temperature range.

- Do not operate the device in direct sunlight or near a heating appliance because these conditions can increase the temperature of the air coming out of the device.
- Contact your health care professional if symptoms of sleep apnea recur.
- If you notice any unexplained changes in the performance of this device, if it is making unusual or harsh sounds, if it has been dropped or mishandled, if water is spilled into the enclosure, or if the enclosure is broken, disconnect the power cord and discontinue use. Contact your home care provider.
- Repairs and adjustments must be performed by Resvent authorized service personnel only. Unauthorized service could cause injury, invalidate the warranty, or result in costly damage.
- Do not use any accessories, detachable parts, and materials not recommended by Resvent. Incompatible parts or accessories can result in degraded performance.
- The Health Industry Manufacturers Association recommends that a minimum separation of 16cm be maintained between a wireless phone and a pacemaker to avoid potential interference with the pacemaker.
- Use only power cords supplied by Resvent for this device. Use of power cords not supplied by Resvent may cause overheating or damage to the device and may result in increased emissions or decreased immunity of the equipment or system.
- The device should not be used while stacked or in close approximation to other non-approved devices.
- Use only approved cables and accessories. Misuse may affect EMC performance and should be avoided.
- Inspect the tubing for damage or wear. Discard and replace the tubing as necessary.
- Periodically inspect electrical cords and cables for damage or signs of wear. Discontinue use and replace if damaged.
- To avoid electrical shock, always unplug the power cord from the wall outlet before cleaning the device. DO NOT immerse the device in any fluids.
- Be sure to route the power cord to the outlet in a way that will prevent the cord from being tripped over or interfered with by chairs or other furniture.
- This device is activated when the power cord is connected.
- For safe operation when using a humidifier, the humidifier must always be positioned below the breathing circuit connection at the mask. The humidifier must be level for proper operation.
- Nebulization or humidification can increase the resistance of breathing system filters and the operator must monitor the breathing system filter frequently for increased resistance and blockage to ensure the delivery of the therapeutic pressure.
- Please check whether there is water in the device before use. The maximum fill level is 290 mL.
- Failure to use a mask or accessory that minimizes re-breathing of carbon dioxide or permits spontaneous breathing can cause asphyxiation.
- Do not connect breathing tubes or accessories with any humidifier and ventilator that are not specified for use with these breathing tubes or accessories.
- Do not cover or heat the breathing tube with anything influent the patient end temperature.
- Do not use this device outside the specified ambient temperature range or humidity range. The humidity performance of the device can be compromised when used outside the specified ambient temperature range or humidity range.
- No modification of this equipment is allowed.
- Parts of the equipment are not serviced or maintained while in use with the patient.
- The PATIENT is an intended OPERATOR.  
The Patient can safely use therapy functions of the equipment and this equipment shall not be serviced or maintained while in use with the patient.

- Please first check the breathing tube is connected correctly to avoid strangulation risk due to breathing tube and hoses when used.
  - Do not pull or stretch the tubing. This could result in circuit leaks.
  - If the device is used by multiple persons (such as rental devices), a low-resistance, main flow bacteria filter should be installed in-line between the device and the circuit tubing to prevent contamination.
  - Allow the humidifier heater plate and water to cool down for approximately 15 minutes before removing the water tank. A burn may result from: touching the heater plate, coming in contact with the heated water, or touching the tank pan.
  - **When using wrist pulse oximeter:**
    - prolonged continuous SpO<sub>2</sub> monitoring may increase the risk of monitoring undesirable changes in skin characteristics, such as irritation, reddening, blistering or burns.
    - The wrist pulse oximeter has no alarms. Do not use it in situations where alarms are required.
- Note: refer the user manual of wrist pulse oximeter for more details.

**CAUTION:**















- Medical electrical equipment needs special precautions regarding EMC and needs to be installed according to EMC information, Contact your home care provider regarding EMC installation information.
- Mobile RF communications equipment can affect medical electrical equipment.
- Pins of connectors marked with the ESD warning symbol shall not be touched and connections shall not be made without special precautions. Precautionary procedures include methods to prevent build-up of electrostatic charge (e.g., air conditioning, humidification, conductive floor coverings, non-synthetic clothing), discharging one's body to the frame of the equipment or system or to earth. It is recommended that all individuals that will handle this device understand these precautionary procedures at a minimum as part of their training.
- Condensation may damage the device. If this device has been exposed to either very hot or very cold temperatures, allow it to adjust to room temperature (operating temperature) before starting therapy. Do not operate the device outside of the operating temperature range shown in the Specifications.
- Do not use extension cords with this device.
- Make sure the filter area on the side of the device is not blocked by bedding, curtains, or other items. Air must flow freely around the device for the system to work properly.
- Make sure the gas intake port on the side of the device is not blocked by bedding, curtains, or other items. Air must flow freely around the device for the system to work properly.
- Do not place the device directly onto carpet, fabric, or other flammable materials.
- Do not place the device in or on any container that can collect or hold water.
- A properly installed, undamaged filter is required for proper operation.
- Tobacco smoke may cause tar build-up within the device, which may result in the device malfunctioning.
- Dirty inlet filters may cause high operating temperatures that may affect device performance. Regularly examine the inlet filters as needed for integrity and cleanliness.
- Always ensure that the DC power cord securely fits into your therapy device prior to use. Contact your home care provider or Resvent to determine if you have the appropriate DC cord for your specific therapy device.

- When DC power is obtained from a vehicle battery, the device should not be used while the vehicle's engine is running. Damage to the device may occur.
- Only use a Resvent DC Power Cord and Adapter Cable. Use of any other system may cause damage to the device.
- When change the pressure setting, please consult your doctor.
- Do not position next to a curtain that blocks the flow of cooling air, thereby causing the equipment to overheat.
- Do not block the gas INTAKE PORT, thereby interfering with therapy.
- Please follow the local regulation when disposal the device
- The proper placement and positioning of the MASK on the face is critical to the consistent operation of this equipment.
- Please check that the compatibility of the equipment and all of the parts and accessories used to connect to the patient before use.
- Ensure that the therapeutic pressure settings were determined for the patient individually with the configuration of the equipment to be used, including accessories.
- For multiple patients use, please use personal breathing tube and mask, do not use other.
- You should position the device far away your pets, pests or children when you use the device in home environment.
- In case you feel comfortless when you contact the device. You shall stop to use the device and contact your supplier immediately. Because it may cause allergic reactions.
- Please periodically reassess the setting(s) of the therapy for effectiveness.
- Never install a wet filter into the device. You must ensure sufficient drying time for the cleaned filter.











**Empty the water tank before packing or moving the device!**

## 5 Symbol

The following symbols may appear on the device, power supply and accessories.

Symbol	Definition
	Manufacturer.
	Date of Manufacture.
	Serial number.
	DC Power.
	Temperature limitations at transport and storage.
	Humidity limitations at transport and storage.
	Atmospheric pressure at transport and storage.
	Follow instruction for use. This label on the device points the user to the operator's manual for complete information. In the operator's manual, this symbol cross-references the label.
	The product bears CE mark indicating its conformity with the provisions of the Council Directive 93/42/EEC concerning medical devices and fulfils the essential requirements of Annex I of this directive.
	European Authorized Representative.
	Dispose according to Council Directive 2012/19/EU or WEEE (Waste Electrical and Electronic Equipment).
	Indicates the degree of protection against electric shock according to IEC 60601-1. Class II devices have double or reinforced insulation, as they have no provision for protective grounding.
	Indicates the degree of protection provided by enclosure according to IEC 60601-1.
	Type BF Applied part (classification of medical electrical equipment, type B, as specified by IEC 60601-1).



	The device is not suitable for use in MRI environment.
	Respiratory air humidifier is heated. Do not touch the element.
	Therapy On/Off Button (Starts and stops the airflow for therapy).
	This way up at transport and storage.
	Do not roll.
	Fragile, handle with care.
	Keep dry at transport and storage.
	Keep away from sunlight.
	Stacking limitations.
	Recyclable materials.

## 6 System Contents

Your CPAP system may include the following items:

- CPAP Device
- Power Adapter
- Power Cord
- SD Card
- Flexible Tube: 19 mm or 15 mm tube
- Travel Bag
- User Manual
- Nasal mask or full face mask

**Note:** If any of these items are missing, please contact your home care provider.

## 7 System Overview

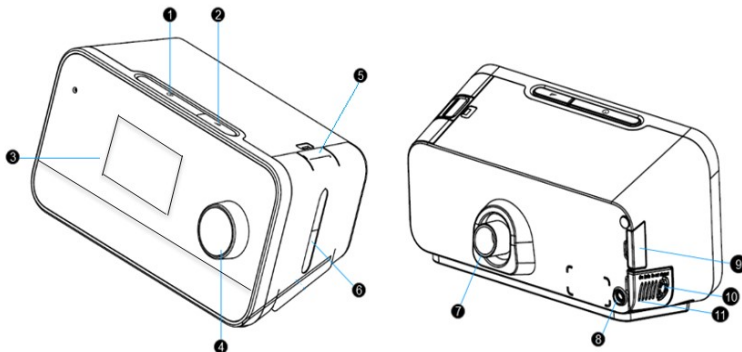

#	Device Feature	Description
1	Therapy On/Off Button	Starts and stops the airflow for therapy.
2	Ramp Key	Activate the ramp feature during therapy.
3	LCD Display screen	This is the User interface for the therapy device.
4	Control Dial	Turn the dial to scroll between options on the screen. Press the dial to choose the option.
5	Water Tank Lock	Press the water tank lock to remove the water tank.
6	Water Tank	This one piece removable water tank holds the water for humidification.
7	Air Outlet Port	Connect the tubing here.
8	Power Inlet	Connect the power cord here.
9	SD card Access Door	This door lifts open for access to SD card.
10	Air Inlet Port	Inlet for room air.
11	Filter Cotton Cover	Open the filter cotton cover to place or change the filter cotton.

### 7.1 Placing the Device

Place the device on a firm, flat surface somewhere within easy reach of where you will use it at a level lower than your sleeping position. Make sure the device is away from any heating or cooling equipment (e.g., forced air vents, radiators, air conditioners).

**Note:** When positioning the device, make sure that the power cable is accessible because removing power is the only way to turn off the device.

#### CAUTION:

- Make sure the filter area on the side of the device is not blocked by bedding, curtains, or other items. Air must flow freely around the device for the system to work properly.
- Do not place the device directly onto carpet, fabric, or other flammable materials.

- Do not place the device in or on any container that can collect or hold water.
- Do not contact the metal surface of the heater when pull out the water tank.

## 7.2 Supplying AC Power

Complete the following steps to operate the device using AC power:

1. Plug the socket end of the AC power cord (included) into the power supply (also included).
2. Plug the pronged end of the AC power cord into an electrical outlet that is not controlled by a wall switch.

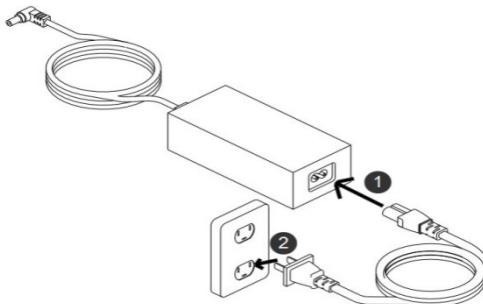

3. Plug the power supply cord's connector into the power inlet on the side of the device.

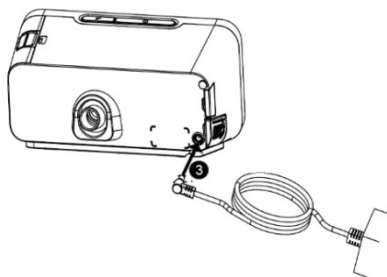

4. Verify that the plug at the side of the device, at the power supply, and at the electrical outlet are fully inserted.
5. When turn off the device Press Therapy On/Off Button and the device will stop work.
6. Disconnecting Network power source.

### WARNING:

- During use if the power cord is disconnected or a power failure, the device buzzer alarm beeps. Please stop using it and check the power status.
- Please do not contact with the DC in connector when it was broken.
- Please avoid arcing, wiggling, or dropping the power supply on hard surfaces.
- Please periodically inspect electrical cords and cables for damage or signs of wear and to discontinue use and replace if damaged.

- Please first check the DC connector could be used normal and not breaking free.
- Never place the power cord around the neck.
- Do not use any small parts to fix power cord in position as they might be accidentally swallowed.

### 7.3 Connecting the Breathing Circuit

To use the system, you need the following accessories in order to assemble the recommended breathing circuit:

- Resvent interface (nasal mask or full face mask) with integrated exhalation port.
- Resvent flexible tubing, 1.8 m.

To connect your breathing circuit to the device, please follow the below steps:

1. Install the connector to the back of the device, and connect the tubing with it.

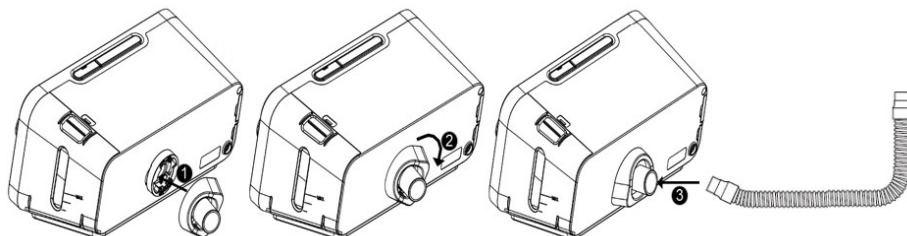

**Note:** If you are using a standard tube (not shown) instead of a heated tube, simply slide the tubing over the air outlet port on the therapy device.

2. Connect the tubing to the mask. For specific parameters and the correct use of the method, please refer to the breathing hose manual.

**WARNING:** Do not pull or stretch the tubing, this could result in circuit leaks.

Inspect the tubing for damage or wear. Discard and replace the tubing as necessary.

3. Attach the headgear to the mask if necessary. For specific parameters and the correct use of the method, please refer to the mask manual.

#### **WARNING:**

- If you are using a full face mask (a mask covering both your mouth and your nose), the mask must be equipped with a safety (entrainment) valve.
- If multiple users share the same equipment, use low-resistance and bacteria-filtered cotton between the equipment and the tube.

**Note:** The selected mask, breathing tube shall meet the performance requirements with good stability. The user should check the mask and tube for damage before each use.

- If necessary, place a bacterial filter in the air outlet of the unit and connect the tube. The use of bacterial filter cotton may affect the equipment work. However, the device can remain functional and be treated.
- Never place the respiration hose around the neck.
- Do not use any small parts to fix the respiration hose in position as they might be accidentally swallowed.
- Do not squash the respiration hose.

## 7.4 Water-filling Operation

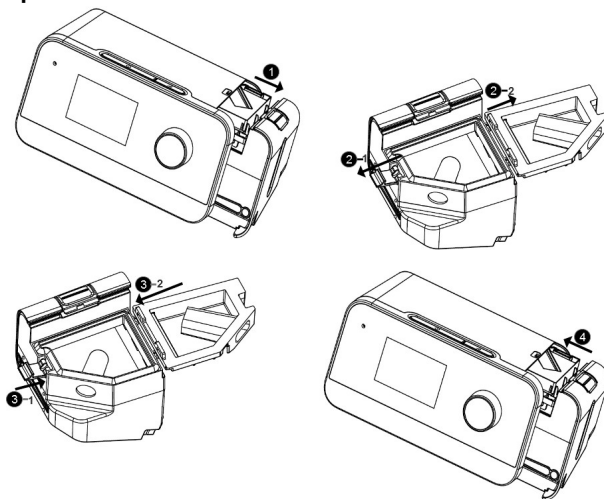

1. Remove the water tank from the device.
2. Open the water tank lid, fill it with water up to the maximum fill line.
3. Lock the water tank lid.
4. Install the water tank on the device.

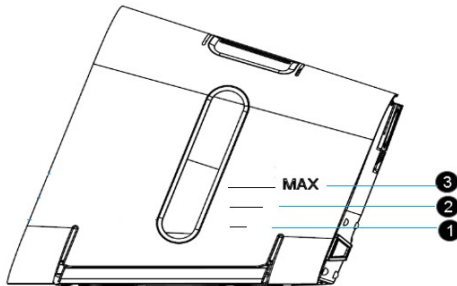

- ❶ The fill line indicates 1/3 water level for safe operation.
- ❷ The fill line indicates 2/3 water level for safe operation.
- ❸ The fill line indicates the maximum water level for safe operation.

### CAUTION:

- Use only room temperature distilled water or purified water.
- Do not fill the water tank above the maximum fill line. If the water tank is overfilled, water may leak into the therapy device, humidifier, or onto your furniture. Damage to the humidifier or therapy device may occur.
- Empty the water tank when the device is not in use.

## 8 Navigating the Device Screens

The User Interface (UI) on this device allows you to adjust the device settings and view information about your therapy. The UI is comprised of the display screen and the control dial. Rotate the control dial in either direction to scroll through the menu options on the display screen.

**Note:** The screen does not support touch operations. You must use the control dial to navigate the device menu.

To adjust a setting:

1. Rotate the control dial to your desired menu option.
2. Press the control dial to select that setting.
3. Rotate the control dial to change the setting.
4. Press the control dial again to save the change.

**Note:** The screens shown throughout this manual are examples for reference only. Actual screens may vary based upon device model and provider settings.

## 9 Operation

This chapter describes basic operation and precautions associated with this device. Each time you turn on the device, it will automatically run set by the user.

### 9.1 Starting the Device

1. Ensure power is supplied to the device. The first screen to display will be the Resvent logo, within 5 second followed by the patient standby screen (See Figure 1).

**Note:** Boot buzzer should be “beep”. If not, you can’t use the equipment and then contact the supplier for inspection.

2. Put on your mask assembly. Refer to the instructions supplied with the mask.
3. Press the Therapy On/Off key on top of the device to turn on airflow and begin therapy. The screen will display to patient therapy clean interface (see Figure 2).
4. Make sure that no air is leaking from your mask. If necessary, adjust the mask and headgear until the air leak stops.
5. If you are using the device in a bed with a headboard, try placing the tubing over the headboard. This may reduce tension on the mask.
6. Press the Therapy On/Off key again to turn off therapy.

**Note:**

1. When any power interruption (e.g., blackout) happens during therapy, the device will resume therapy mode if the power is restored within 60 minutes.
2. Please keep away from incense and candles avoiding catching fire during use.

### 9.2 Patient Menu Navigation Settings

Patient Menu Navigation Setting including Standby interface shortcut operation、Therapy interface shortcut operation、Comfort Parameters setting interface、System setting interface.

#### 9.2.1 Patient Standby Interface

The Patient Standby Interface displays setup menus for the system main features, and the icons to indicate the current enabled features.

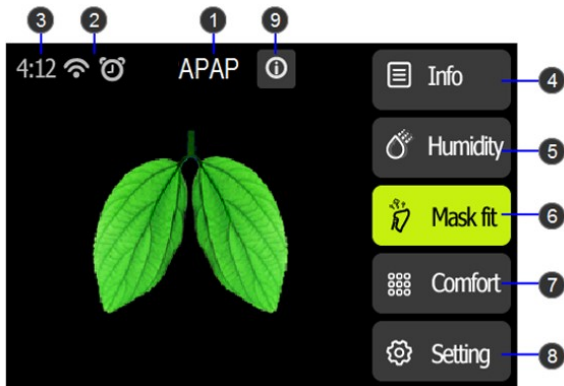

Figure1 Patient Standby Interface

#	Feature	Description
1	Mode	Display the current mode.
2	Enabled features	Depending on setup, certain enabled therapy features will display here.
3	Time	Display the current time.
4	Patient Sleep Quality Report	Displays the patient sleep quality report and the options for period of the report are: daily (recent 6 days) / 7 days / 14 days / 1 month / 3 months / 6 months / 1 year.
5	Humidity	Set humidifier level to enhance patient comfort of respiration. Option: Auto / OFF / 1-8                      Default: 3 Note: 1.The humidity level only can be set when the water in humidifier exceeds the minimum water level for safe operation. 2. The option Auto is not available in the iBreeze 20C.
6	Mask fit	Mask fit feature allows you to check the fit of your mask prior to starting therapy. This is done by measuring the amount of leak.
7	Comfort	Press to enter Comfort setting interface.
8	Setting	Press to enter Patient System Setting interface.
9	Alarm Message	Display the alarm messages.

### 9.2.2 Patient Therapy Interface

When the therapy starts, the screen will switch to the Patient Therapy Interface, which displays the therapy parameters monitoring during therapy (See Figure2). The displayed parameters depend on the current therapy mode.

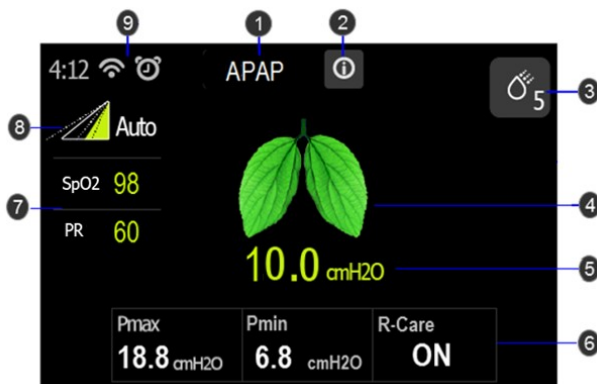



Figure2 Patient Therapy Interface



#	Description
1	The current therapy mode.
2	Display the alarm messages.
3	Humidity adjustment shortcut key and humidity level. Note: The humidity level is available when the humidity function is on.
4	Background breathing dynamic diagram.
5	The current therapy pressure.
6	The therapy parameters monitoring during therapy.
7	Displays the oxygen saturation and pulse rate values when the oximeter adapter is connected.
8	Ramp time dynamic diagram. Note: Only available when the Ramp function is on.
9	Work status icon bar.

### 9.2.3 Patient Comfort Setting

Press  key in the Patient Standby interface to enter Patient Comfort Setting Interface.





Icon	Text	Description
	IPR	Set IPR (Intelligence Pressure Release) level. Option: OFF / 1-3                      Default: 2
	Tube Type	Set the Tube type. Option: 15 mm / 19 mm                      Default: 15 mm
	Mask Type	Set the Mask type. Option: Full Face / Nasal / Pillow      Default: Nasal

### 9.2.4 Patient System Setting

Press key  in the Patient Standby interface to enter Patient Setting interface.

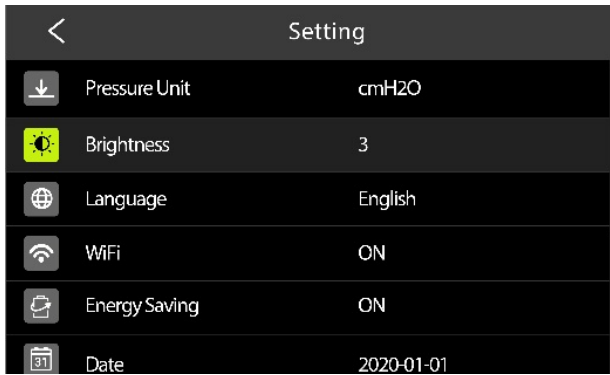





Figure4 Patient Setting Interface

Icon	Text	Description
	Pressure Unit	Set the pressure unit. Option: hPa / cmH <sub>2</sub> O                      Default: cmH <sub>2</sub> O
	Screen Brightness	Adjust the Screen Brightness. Option: Auto / 1-3                      Default: 2
	Language	Set the system interface language. Option: English / Chinese / French / Spanish / Russian / Polish Default: English. Note: Not all the languages are available, the optional items depend on software version.





Item	Description
Period	Set the time interval covered by the report. Options: daily (for recent 6 days) / 7 days / 14 days / 1 month / 3 months / 6 months / 1 year.
Usage	Number of hours the device has been used in the selected period.
AHI	The average apnea-hypopnea index in the selected period.
Mask fit	Use three stars for rating the leakage of mask in the selected period. ★★★ The mask seal status is good. ★☆☆ The mask needs adjustments.
Humidify	Use three stars for rating the usage time of humidifier in the selected period. ★★★ Humidifier has been used more than 60% of the total therapy time. ★☆☆ Humidifier has been used less than 5% of the total therapy time.
SpO <sub>2</sub> (optional)	The average SpO <sub>2</sub> in the selected period.
PR(optional)	The average PR (Pulse Rate) in the selected period.

### 9.2.6 SD Card

The iBreeze system comes with an SD card already inserted in the device to store therapy information for the home care provider.

Your home care provider may ask you to send the SD card to them for evaluation.

To remove the SD card:

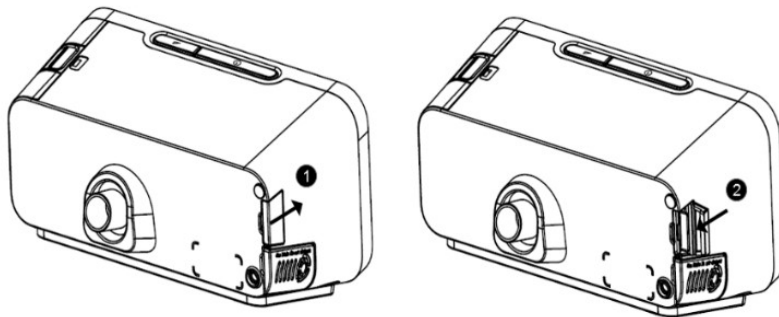

1. Stop therapy and open the SD card cover.

2. Push in the SD card to release it. Remove the SD card from the device.

Place the SD card in the protective folder and send it to your care provider.

**Note:**

1. Do not remove the SD card from the device during therapy.
2. Do not use the SD card for any other purpose.
3. This device can use only manufacturer SD card. Please contact your supplier for purchasing.

**9.2.7 Wireless transmission module****9.2.7.1 Wifi module connection**

There are 2 methods for the device to match WiFi network, connect to the network through APP and connect to the network through the device.

**Method 1: Connect to the network through APP**

- ① Power on and start up the device, enter the setting interface—Wifi—set to On.
- ② Download “ResAssist” APP, IOS system downloads from the “App store”, Android system downloads from the “Google Play”. Register for an account after downloading is finished. Step 1, use the mobile phone number or email to register a new account number; Step 2, use the serial number of the device to register the user information, complete the two steps and then registered successfully.
- ③ Log in “ResAssist” APP with the registered account, turn on the Bluetooth of your phone, click the “My” icon in the lower right corner—“WIFI settings”, enter Wifi setting interface.
- ④ Follow the steps on the APP interface, match Wifi network to the device, until Wifi connected successfully.
- ⑤ Sign of Wifi connected successfully: ResAssist APP shows “Connection successful” or there is an icon on the standby interface to remind the connection is successful, the

icon is .

**Method 2: Connect to the network through the device**

- ① Power on and start up the device, enter the setting interface—Wifi—set to On.
- ② WiFi interface on the device, click “search”—search for the WiFi signals nearby—enter the WiFi list interface.
- ③ Click on an available Wifi—enter the Wifi password input interface, enter the correct password -- until Wifi connected successfully.
- ④ Sign of connection successful: Wifi status is connected, Wifi status icon

is .

**9.2.7.2 Usage of Wifi module**

- ① The method for the device to connect WiFi network is through APP or through the device.
- ② Press the Therapy On/Off key on top of the device to turn on airflow and begin therapy.
- ③ The device ventilation effectively (Put on the mask and breathe normally) for a period of time and then stop it, Wifi connect normally and begin to upload data, Wifi icon signs an up arrow in the lower right corner.
- ④ After data upload, log in the Cloud, view the treatment data uploaded from the cloud.

### 9.2.7.3 Wifi status sign

- ① Wifi Off
- ② Wifi On, WLAN hotspots unconnected
- ③ Wifi On, WLAN hotspots connected but inaccessible to the sever
- ④ Wifi connect normally
- ⑤ Wifi upload data

no Wifi sign



## 10 Device Alert

There are 4 types of alerts described here::

- **Alert 0:** Gray bottom white tips, no light, no sound, always display, disappear until the prompt condition not met.
- **Alert 1:** Orange bottom white tips, blue-ray flashing, with sound, always display, disappear until the prompt condition not met.
- **Alert 2:** Red bottom white tips, blue-ray flashing, with sound, exclusive alarm until the user opens the alert to confirm or press the Therapy On/Off key.
- **Notification:** White reminder message, no light, no sound, after the corresponding process, the message automatically disappears.

Alert Summary Table: The following table summarizes the alerts.

Alert	Type	Possible Cause	Action
Input voltage is abnormal, please check!	Alert 2	Power Adapter with the wrong type, resulting in voltage is too high or too low	Use the Power Adapter provided by Resvent.
SD card write/read underway, do not remove the SD card, do not cut off the power.	Notification	1. Insert SD card during data synchronization; 2. Input the configuration on the SD card.	No action.
SD Card Removed.	Notification	1. No SD card in the device. 2. SD card has been removed.	Reinsert functional SD card.
SD Card Full, Please replace the SD Card.	Notification	In Standby mode, SD card storage space only 200M	Replace the SD card or clean the data after export the data in the SD card.
SD card can't be written, please	Notification	The SD card is read-only and can't be	Remove the SD card, unlock and insert it

Alert	Type	Possible Cause	Action
unlock and insert again.		written.	again.
SD card error, please remove and insert again.	Notification	SD card failure, may be: 1.SD card can't read and write. 2.SD card read and write data errors.	Remove SD Card, Reinsert or replace with a new card.
Non-original card,continue using please format.	Notification	Insert other device' SD card in non-service mode.	Format the SD card in your computer and then insert it to device.
Software update underway, Do not cut off the power!	Notification	Software update.	No action.
System error code: XXXX Please try to restart, please contact the supplier if repeat.	Alert 2	1. Pressure sensor failure, flow sensor failure, blower failure in therapy state; 2. Power board short-circuit 3. Humidifier heating circuit short-circuit	Please try to restart, please contact the supplier if repeat.
The respiration tube expired, please replace.	Notification	In standby state, the usage time exceed the respiration tube setting service life.	Click "Confirm", replace the respiration tube.
The water tank expired, please replace.	Notification	In standby state, the usage time exceed the water tank setting service life.	Click "Confirm", replace the water tank.
The filter expired, please replace.	Notification	In standby state, the usage time exceed the filter setting service life.	Click "Confirm", replace the filter
The mask expired, please replace.	Notification	In standby state, the usage time exceed the mask setting service life.	Click "Confirm", replace the mask
It is time for device maintenance, Please contact the service provider for	Notification	In standby state, the usage time exceed the setting device maintenance time.	Click "Confirm", contact the service provider for device maintenance.



Alert	Type	Possible Cause	Action
device maintenance.			
Low Minute Volume (MV).	Alert 0	Minute volume less than the setting threshold value.	Check the respiration tube or adjust therapy parameter setting.
High Respiratory Rate (RR).	Alert 0	Respiratory Rate exceed the setting threshold value.	Check the respiration tube or adjust therapy parameter setting.
Low Respiratory Rate (RR).	Alert 0	None.	Check the respiration tube or adjust therapy parameter setting.
Apnea.	Alert 1	An apnea is detected and exceeds the setting duration.	Check the respiration tube or adjust therapy parameter setting.
High Leakage Volume.	Alert 1	1. Inappropriate connection of mask and respiration tube. 2. The water tank is not plugged in.	Check the connection of the mask or respiration tube, and the connection of the water tank.
High Inspiration Pressure.	Alert 0	During breath cycle monitored pressure is higher than the set pressure threshold.	Check the respiration tube or adjust therapy parameter setting.
Low Expiratory Pressure.	Alert 0	During breath cycle monitored pressure is lower than the set pressure threshold.	Check the respiration tube or adjust therapy parameter setting.
Mask vent holes blocked.	Alert 1	Mask vent holes is blocked.	Check the mask.
Low Tidal Volume (Vt).	Alert 0	During breath cycle, Average Vt less than $0.6 \times \text{Setting Value}$ .	Check the respiration tube or adjust therapy parameter setting.
System Drying	Notification	The device generates a small flow to dry the system when it is the standby mode after 30 minutes usage with humidification.	No action.
Low battery charge, reports may not be saved.	Notification	Low button battery power.	Please contact the supplier if you want reports be saved.

Alert	Type	Possible Cause	Action
RTC clock failure. Reports may not be saved.	Alert1	RTC clock failure.	Please contact the supplier if you want reports be saved.

**Note:** Some alert messages depend on the device model.

## 11 Troubleshooting

If your device has the following problems in the usage, please try the following measures. If it can't be resolved, please contact the maintenance provider.

Problem	Possible Cause	Action
Nothing happens when you apply power to the device. The backlights on the keys do not light.	There's no power at the outlet or the device is unplugged.	Check the outlet and verify that the device is properly plugged in. Make sure there is power available at the outlet. Make sure the AC power cord is connected correctly to the power supply and the power supply cord is securely connected to the device's power inlet. If the problem continues to occur, contact your home care provider. Return both the device and power supply to your provider, so they can determine if the problem is with the device or power supply.
Air is leaking from around my mask	Mask may be fitted incorrectly.	Make sure your mask is fitted correctly. See your mask user guide for fitting instructions or use the Mask Fit function to check your mask fit and seal.
I am getting a dry or blocked nose	Humidity level may be set too low.	Adjust the Humidity Level.
I am getting droplets of water on my nose, in the mask and air tubing	Humidity level may be set too high.	Adjust the Humidity Level.
My mouth is very dry	Air may be escaping through	Increase the Humidity Level.

Problem	Possible Cause	Action
and uncomfortable	your mouth.	You may need a chin strap to keep your mouth closed or a full face mask.
Air pressure in my mask seems too high (it feels like I am getting too much air).	Ramp may be turned off.	Use the Ramp Time option.
Air pressure in my mask seems too low (it feels like I am not getting enough air).	Ramp may be in progress.	Wait for air pressure to build up or turn Ramp Time off.
I have stopped therapy, but the device is still blowing air.	Device is cooling down.	Device blows a small amount of air in order to avoid condensation in the air tubing. It will stop automatically after a few minutes.
The device's display is erratic (crash blank or blue screen).	The device has been dropped or mishandled.	Unplug the device. Reapply power to the device. If the problem continues, contact your home care provider.
My water tank is leaking.	Water tank may not be assembled correctly. Water tank may be damaged or cracked.	Check for damage and reassemble the water tank correctly. Contact your care provider for a replacement.
Key exception (non-responsive or insensitive).	Program crashes or key misalignment.	Unplug the device. Reapply power to the device. If the problem continues, contact your home care provider.
The knob is insensitive.	Encoder is damaged	Unplug the device. Reapply power to the device. If the problem continues, contact your home care provider.
The touchscreen is not working.	The touchscreen is damaged	Unplug the device. Reapply power to the device. If the problem continues, contact your home care provider.

## 12 Cleaning and Maintaining

To avoid prolonged exposure to dusty and humid environment, resulting in impaired performance and reliability, the user must clean the device regularly. The clean interval of the device and accessories, please refer the below table:

Interval	Action
Weekly	Clean the device. Clean the tube. Clean the water tank.
Monthly	Clean the air filter.
Every 6 months	Replace the air filter.
Annually	Replace the tube.
As necessary	Descalcify the water tank. In clinical areas: Disinfect the tube. For reasons of hygiene: Replace the water tank if it is in poor condition (e.g., if cracks appear).
When changing patients	If the device has been used without a bacteria filter: Have professional hygienic preparation performed before using the device again. Send the device to the authorized dealer.

### 12.1 Cleaning the Device

**WARNING:** To avoid electrical shock, always unplug the power cord from the wall outlet before cleaning the device. Do not immerse the device in any fluids.

1. Unplug the device, Wipe the outside of the device using a cloth slightly dampened with water and a mild detergent. Let the device dry completely before plugging in the power cord.
2. Inspect the device and all circuit parts for damage after cleaning. Replace any damaged parts.

### 12.2 Cleaning the Tube/Water Tank

Clean the flexible tube and water tank before first use. Remove the flexible tube and water tank from the device. Gently wash the tube and water tank in a solution of warm water and a mild detergent. Rinse thoroughly and allow to dry out of direct sunlight or heat.

### 12.3 Installing/Replacing the Air Filter

The device comes with a reusable air filter, it must be in place at all times when the device is operating. Please check the air filter every 1-3 months, clean or replace it if there are any holes or blockages by dirt or dust.

**Note:** When you receive your device, if the filter cotton is not installed, you must install the filter cotton before using the device.

To install or replace the air filter, please follow the below steps:

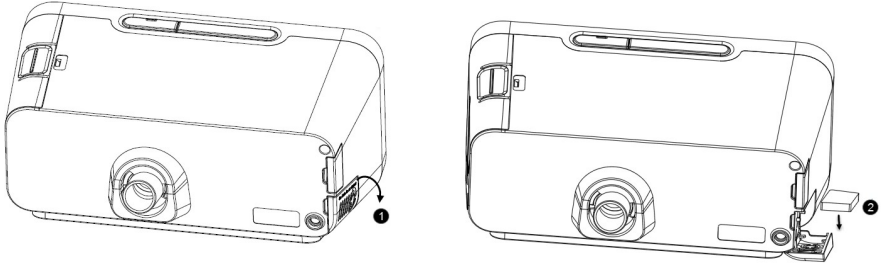

1. Open the air filter cover.
2. Place a filter cotton onto the air filter cover and then close it.  
If replacing, remove the old filter cotton and then place a new one.

#### **12.4 Traveling with the Device**

Use the Resvent travel bag to carry the device and accessories when traveling.

Please follow the below steps for packing:

1. Remove the water tank from the device and pour out all water.
2. Install the water tank back on the device.
3. Put the device and accessories in the travel bag.

#### **12.5 Device Maintenance**

No regular maintenance is required. If you notice abnormal running of the device, abnormal sounds, device or power supply drops from the tabletop, or have mistakenly operated, liquid has entered the device and the cover has ruptured, disconnect the power and contact your supplier.

#### **13 Maintenance**

RESVENT CPAP therapy device is designed to have a useful service life of 10 years. If the therapy device is used as intended in accordance with the instructions for use, it does not require any maintenance within this period. If the therapy device is used beyond this period, we recommend having it checked by an authorized dealer. If the respiratory air humidifier is used as intended in accordance with these instructions for use, it does not require any maintenance. If you identify faulty parts during the function check, please contact your authorized dealer immediately.

## 14 Storage and Disposal

### 14.1 Storage

#### 14.1.1 Storage Information

Store the device under the prescribed ambient conditions.

#### 14.1.2 Storing the therapy device.

- Switch off the therapy device.
- Disconnect the therapy device from the power supply.
- Clean the therapy device, components, and accessories.
- Store the therapy device, components, and accessories in a dry place.

### 14.2 Disposal



Electronic waste 

Do not dispose of the product in the household waste. Consult an authorized, certified electronic waste recycling company for proper disposal. You can find out their address from your environmental officer or from your local council.

The device packaging (cardboard box and inserts) can be disposed of as waste paper.

#### **Risk of injury if disposable items are reused!**

Disposable items are only intended to be used once. Reused disposable items may be contaminated and/or not functions correctly and thus cause patient injury.

## 15 Specification

### Physical

Dimension (L\*W\*H): 238\*178\*128 mm

Weight: Approximately 1.60 kg

### Operating Environmental

Temperature: 5°C~35°C

Relative Humidity: 10%~95% (non-condensing)

Atmospheric Pressure: 70 kPa~106 kPa

### Storage Environmental

Temperature: -25°C~70°C

Relative Humidity: 5%~95% (non-condensing)

Atmospheric Pressure: 70 kPa~106 kPa

### Noise Value

Sound pressure level	Uncertainty	Sound power level	Uncertainty
28 dB(A)	2 dB(A)	36 dB(A)	2 dB(A)

### Standards compliance

IEC 60601-1:2005 Medical electrical equipment - Part 1: General requirements for basic safety and essential performance.

IEC 60601-1-2:2014 Medical electrical equipment - part 1-2: general requirements for basic safety and essential performance - collateral standard: electromagnetic disturbances - requirements and tests.

ISO 80601-2-70:2015 Medical electrical equipment - Part 2-70: Particular requirements for basic safety and essential performance of Sleep apnea breathing therapy equipment.

ISO 8185:2009 Respiratory tract humidifiers for medical use - Particular requirements for respiratory humidification systems.

IEC 60601-1-11:2015 Medical electrical equipment - Part 1-11: General requirements for basic safety and essential performance –Collateral Standard: Requirements for medical electrical equipment and medical electrical systems used in the home healthcare environment.

### Electrical

Specified power supply: Resvent Medical Technology Co., Ltd.

Model: DA60-220S24-W1

AC Input: 100-240V~1.18-0.56A 50/60Hz 2A Max

DC Output: 24 V=2.5 A

Specified power supply: SHANGHAI BIAOJUN ELECTRONICS TECHNOLOGY Co., Ltd.

Model: JE01-40-006HM

AC Input: 100-240V~50/60Hz 2A Max

DC Output: 24V=2.5 A

## Safety Specifications

Class II

Type BF

Ingress Protection: IP22

## Air filter

Air filter: Filter Efficiency: >75% (7 micron dust)

## Pressure

Setting Range: 4-20 cmH<sub>2</sub>O

Max Single Fault Steady Pressure: 40 cmH<sub>2</sub>O

Static Pressure Accuracy:  $\pm 0.5$  cmH<sub>2</sub>O (Expanded uncertainty: 1.87%)

Dynamic Pressure Accuracy:  $\pm 1$  cmH<sub>2</sub>O (Expanded uncertainty: 2.55%)

Pressure monitoring Accuracy:  $\pm (2\% * \text{full scale reading} + 4\% * \text{actual reading})$

## Flow

		Test pressure (cmH <sub>2</sub> O)				
		4	8	12	16	20
19mm breathing tubing	Measured pressure at the patient connection port (cmH <sub>2</sub> O)	2.9	7.1	11.0	15.1	19.1
	Average flow at the patient connection port (L/min)	154.3	146.4	135.7	125.3	114.1
15mm breathing tubing	Measured pressure at the patient connection port (cmH <sub>2</sub> O)	2.9	6.9	10.8	14.8	18.7
	Average flow at the patient connection port (L/min)	141.4	132.7	124.2	114.3	85.4

## Humidifier

Water capacity: 290 ml (MAX Water Level)

Humidity: >10 mg/L BTPS (Within the set pressure range)

## Wrist Pulse Oximeter:

Model: MD300W314B4

SpO<sub>2</sub> Range: 70%~100%

SpO<sub>2</sub> Accuracy: 70%~100%:  $\pm 2\%$ ; <70%: unspecified

Pulse Rate Range: 30~250 bpm

Pulse Rate Accuracy: 30~99 bpm:  $\pm 2$  bpm; 100~250 bpm:  $\pm 2\%$

Note: refer the user manual (version: Ver1.0w314B4) for more details.



Model: SONOSAT-W01LT

SpO<sub>2</sub> Range: 0%~100%

SpO<sub>2</sub> Accuracy: 70%~100%:  $\pm 2\%$ ;

Pulse Rate Range: 18~250 bpm

Pulse Rate Accuracy: 18~250 bpm:  $\pm 3$  bpm;

Note: refer the user manual (version: 1.1) for more details.

Model: iPOM, iPOM Lite

SpO<sub>2</sub> Range: 70%~100%

SpO<sub>2</sub> Accuracy: 80%~100%:  $\pm 2\%$ ; 70%~79%:  $\pm 3\%$

Pulse Rate Range: 30~250 bpm

Pulse Rate Accuracy:  $\pm 2$  bpm or  $\pm 2\%$ , whichever is greater

Note: refer the user manual (version: A) for more details.

## 16 EMC Declaration

Essential Performance:

CPAP mode: work pressure 10 cmH<sub>2</sub>O.

The CPAP system is intended for use in the specified electromagnetic environment listed in form A-1, A-2 and A-3. The customer or the user of CPAP system should assure that it is used in such an environment as described below.

The CPAP system is intended for use in an electromagnetic environment in which radiated RF disturbance are controlled. The customer or the user of CPAP system can help prevent electromagnetic interference by maintaining a minimum distance between portable/mobile RF communications equipment (transmitters) and the CPAP system (as recommended in form A-3) , according to the maximum output power of the communications equipment.

### Form A-1 Guidance and Declaration - Electromagnetic Emissions

Emissions test	Compliance	Electromagnetic environment - guidance
Radiated emissions CISPR11	Group 1	The CPAP system uses RF energy only for its internal function. Therefore, its RF emissions are very low and are not likely to cause any interference in nearby electronic equipment.
Conducted emissions CISPR11	Class B	The CPAP system is suitable for use in all establishments, including domestic establishments and those directly connected to the public low-voltage power supply network that supplies buildings used for domestic purposes.
Harmonic emissions IEC 61000-3-2	Class A	
Voltage fluctuations/flicker emissions IEC61000-3-3	Complies	

## Form A-2 Guidance and Declaration - Electromagnetic Immunity

Immunity test	IEC60601test level	Compliance level	Electromagnetic environment - guidance
Electrostatic discharge (ESD) IEC61000-4-2	Contact: $\pm 8\text{kV}$ Air: $\pm 15\text{kV}$	Contact: $\pm 8\text{kV}$ Air: $\pm 15\text{V}$	Floors should be wood, concrete or ceramic tile. If floors are covered with synthetic material, the relative humidity should be at least 30%.
Electrical fast transient/burst IEC61000-4-4	Power supply lines: $\pm 2\text{kV}$ input/output lines: $\pm 1\text{kV}$	Power supply lines: $\pm 2\text{kV}$ input/output lines: $\pm 1\text{kV}$	Mains power quality should be that of a typical commercial or hospital environment.
Surge IEC61000-4-5	line(s) to line(s): $\pm 1\text{kV}$ line(s) to earth : $\pm 2\text{kV}$	line(s) to line(s): $\pm 1\text{kV}$ line(s) to earth: $\pm 2\text{kV}$	Mains power quality should be that of a typical commercial or hospital environment.
Voltage dips, short interruptions and voltage variations on power supply input lines IEC61000-4-11	0%, 70%, 0% of UT	0% for 0.5 cycle	Mains power quality should be that of a typical commercial or hospital environment.
		0% for 1 cycle	
		70% for 25 cycles	
		0% for 250 cycles	
Power frequency (50/60Hz) magnetic field IEC61000-4-8	50Hz,60Hz 30A/m	50Hz:30A/m 60Hz:30A/m	Mains power quality should be that of a typical commercial or hospital environment.
Conducted RF IEC61000-4-6	150KHz to 80MHz 3Vrms ISM and amateur radio bands between 150KHz to 80MHz 6Vrms	3Vrms 6Vrms (in ISM and amateur radio bands) 80% AM at 1kHz.	Portable and mobile RF communications equipment should be used no closer to any part of the CPAP system, including cables, than the recommended separation distance

Immunity test	IEC60601test level	Compliance level	Electromagnetic environment - guidance
			calculated from the equation appropriate for the frequency of the transmitter. Recommended separation distances: $d=0.35\sqrt{P}$ $d=1.2\sqrt{P}$
Radiated RF IEC61000-4-3	80MHz to 2700MHz 10V/m (rms) 385MHz 27V/m (rms) 450MHz 28V/m (rms) 710MHz, 745MHz, 780MHz 9V/m (rms) 810MHz, 870MHz, 930MHz 28V/m (rms) 1720MHz, 1845MHz, 1970MHz 28V/m (rms) 2450MHz 28V/m (rms) 5240MHz, 5500MHz, 5785MHz 9V/m (rms)	10V/m, 80% AM at 1kHz 27V/m PM at 18Hz 28V/m FM $\pm$ 5 kHz deviation at 1kHz sine 9V/m PM at 217 Hz 28V/m PM at 18Hz 28V/m PM at 217 Hz 28V/m PM at 217 Hz 9V/m PM at 217 Hz	80MHz to 800MHz: $d=1.2\sqrt{P}$ 800MHzto 2.5GHz: $d=2.3\sqrt{P}$ Where, P is the maximum output power rating of the transmitter in watts (W) according to the transmitter manufacturer and d is the recommended separation distance. Field strengths from fixed RF transmitters, as determined by an electromagnetic site survey, should be less than the compliance level in each frequency range. Interference may occur in the vicinity of equipment marked with the following symbol: 

Form A-3.Recommended Separation Distance between Portable/Mobile RF Communications Equipment and the CPAP system.

Rated maximum output power of transmitter(W)	Separation distance in meters (m) according to frequency of the transmitter		
	150kHz~80MHz $d=1.2\sqrt{P}$	80MHz-800MH z $d=1.2\sqrt{P}$	800MHz-2.5GHz $d=2.3\sqrt{P}$
0.01	0.12	0.12	0.23
0.1	0.38	0.38	0.73
1	1.2	1.2	2.3
10	3.8	3.8	7.3
100	12	12	23

## **Statement**

Resvent Medical Technology Co., Ltd. (hereinafter called "Resvent") owns the intellectual property rights to this manual. Resvent intends to maintain the contents of this manual and confidential information.

This manual serves as a reference. The instruction in this manual is not intended to supersede the health care professional's instructions regarding the use of the device. Disclosure of the information in this manual in any manner whatsoever without the written permission of Resvent. Release, amendment, reproduction, distribution, rental, adaptation or any other derivative work of this manual in any manner whatsoever without the written permission of Resvent is strictly forbidden.

All information contained in this manual is believed to be correct. Resvent shall not be liable for errors contained herein or for incidental or consequential damages in connection with the furnishing, performance, or use of this manual. Contents of this manual are subject to change without prior notice.

## **Limited Warranty**

Resvent warrants that the system shall be free from defects of workmanship and materials and will perform in accordance with the product specifications within the warranty period. During the warranty time, If the product fails to perform in accordance with the product specifications, Resvent will repair or replace – at its option – the defective material or part. Resvent will pay customary freight charges from Resvent to the dealer location only. This warranty does not cover damage caused by accident, misuse, abuse, alteration, water ingress, and other defects not related to material or workmanship.

To exercise your rights under this warranty, contact your local authorized dealer or Resvent.

## **Contact information**

Manufacturer:

Resvent Medical Technology Co., Ltd.

Registration / Factory address:

Room-602, Building B&C, Gaoxinqi

Industrial Park, Liuxian No.1 Road,

Xingdong Community, Bao'an, 518100

Shenzhen, PEOPLE'S REPUBLIC OF

CHINA

Tel: 0086-755-23027370

Fax: 0086-755-23027370

<http://www.resvent.com>

Issue date: Jun.,2021

© Resvent Medical Technology Co., Ltd.

All rights reserved

H-4000-000002-00 V6.0

# Quick Operation Guide

1

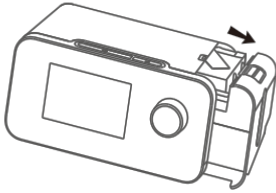

Remove the humidifier chamber.

2

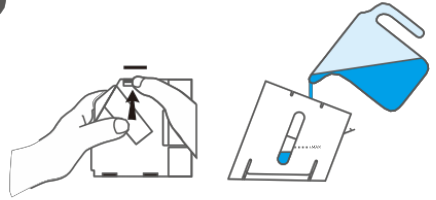

Open the lid, fill pour water to the maximum mark.

3

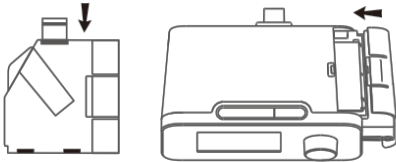

Close the lid and insert the chamber back.

4

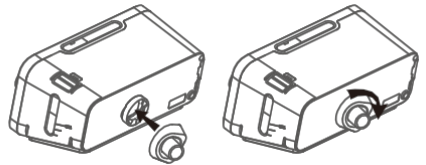

Lock the outlet onto back of device by turning outlet clockwise.

5

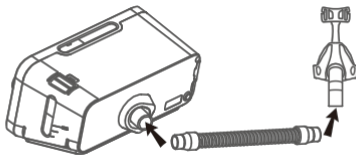

Connect one side of the tube to the air outlet and mask at the other end.

6

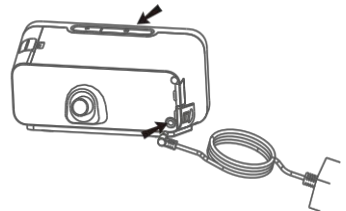

Connect the power supply to the device. Fit mask and press start button to initiate therapy.